

GalvinAssist[®] Straight and Angled Grab Rails

PRODUCT CODES:

- | | | |
|----------------|------------------|-------------------|
| - 105.00.00.01 | - 105.07.23.01* | - 105.41.07.31*** |
| - 105.00.03.01 | - 105.05.03.31* | - 105.41.07.41*** |
| - 105.00.06.01 | - 105.05.03.41* | |
| - 105.00.08.01 | - 105.08.09.31** | |
| - 105.00.09.01 | - 105.08.09.41** | |
| - 105.00.11.01 | - 105.05.08.31** | |
| - 105.00.12.01 | - 105.05.08.41** | |

SPECIFICATIONS

- The GalvinAssist[®] range of Stainless Steel grab rails provides safe and reliable fixtures for WC's and accessible areas in health institutions, hospitals and detention facilities.
All the items can comply with clause 17 of AS 1428.1-2009 if positioned correctly according to the standard.
- * Items noted can comply with clause 16.2 of AS1428.1-2009 for sanitary compartment for people with ambulant disabilities if positioned correctly according to the standard.
- ** Items noted can comply with clause 15.2.7 of AS1428.1-2009 for sanitary facilities if positioned correctly according to the standard.
- ***Items noted can comply with clause 15.5.4 of AS1428.1 -2009 for sanitary facilities.

TECHNICAL DATA

Fixings:	Rails are supplied with stainless steel fixing screws
Finish:	Satin Stainless Steel

NOTE: Galvin Specialised continually strive to improve their products. Specifications may change without notice.

MOUNTING DETAILS

⚠ TOGGLE BOLTS FIXED INTO TILES, PLASTER BOARD OR OTHER WATER PROOF WALLS ARE NOT SATISFACTORY OR SAFE.

Grab rails must be fitted to a solid wall or other firm surface and installed by a qualified trades person.

5 x 8mm fixing holes

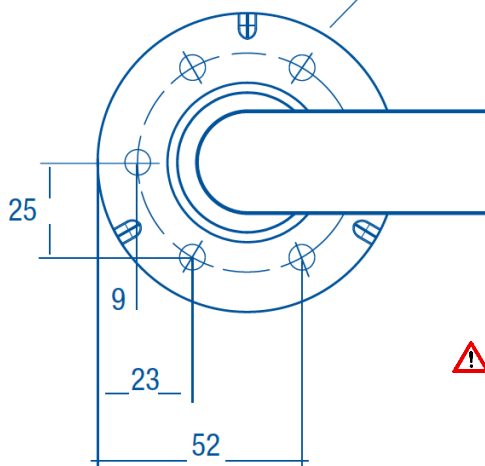

- At least 2 fixing points must be used on each flange
- Caulking may be used around flanges to prevent moisture seepage.
- Clean with mild soap and rinse with warm water.
- Avoid prolonged exposure to any solutions containing chlorides or acids.



WARNING: Install with stainless steel 304 or 316 screws. Other types of screws may rust and void warranty.



Product Installation Guideline

Version 1, 23 June 2020, Page 2 of 3

MOUNTING TO TIMBER

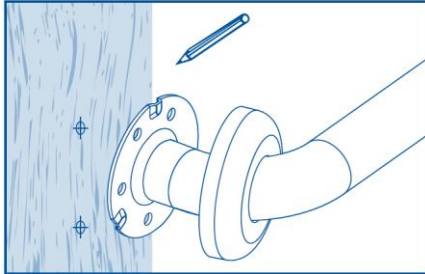

Place grab rail on wall in line with studs and mark location of screw holes.

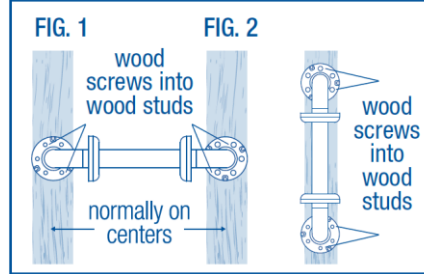
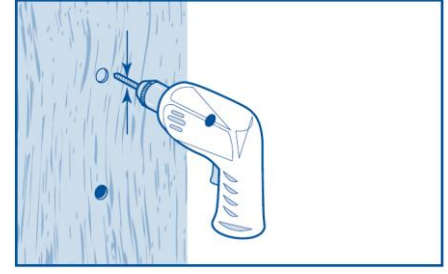
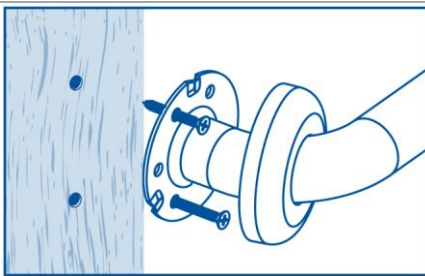

Fig. 1 – Horizontal attachment.
Fig. 2 – Vertical attachment.



After marking, drill small hole to confirm location of stud.



Use 50mm x 14g self-tapping stainless steel screws supplied.

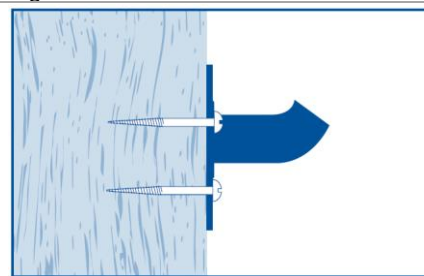

Ensure screws are fully engaged within substrate.

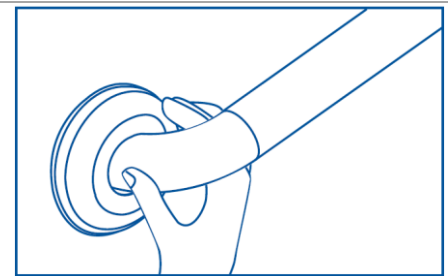

Press flange covers over the wall flanges.

MOUNTING TO MASORY

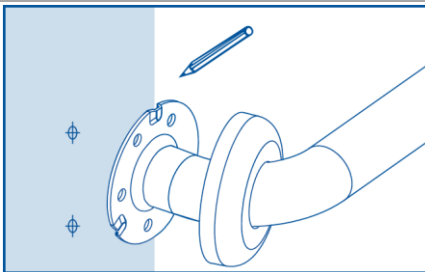

Place grab rail on wall and mark location of screw holes.

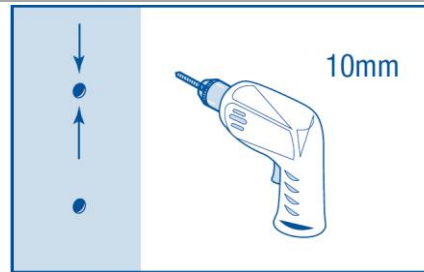

Drill 10mm holes.

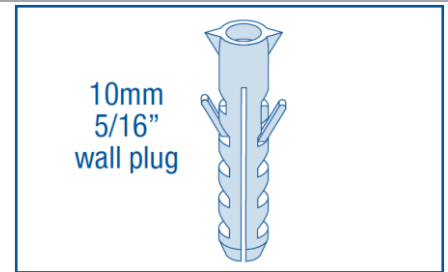

Use wall plugs supplied.

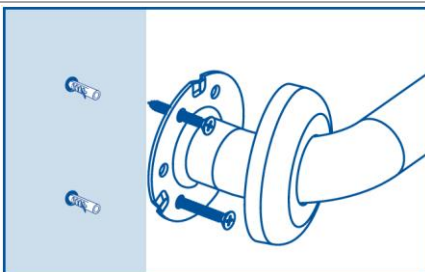

Use 50mm x 14g self-tapping stainless steel screws supplied.

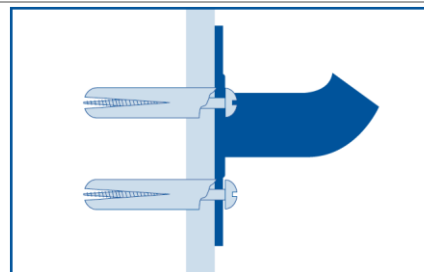

Ensure screws are fully engaged within substrate.

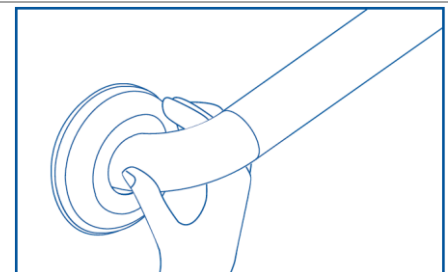

Press flange covers over the wall flanges.



WARRANTY

The warranty set forth herein is given expressly and is the only warranty given by the Galvin Engineering Pty Ltd. With respect to the product, Galvin Engineering Pty Ltd makes no other warranties, express or implied. Galvin Engineering Pty. Ltd. hereby specifically disclaims all other warranties, express or implied, including but not limited to the implied warranties of merchantability and fitness for a particular purpose.

Galvin Engineering Pty Ltd products are covered under our manufacturer's warranty available for download from www.galvinengineering.com.au Galvin Engineering Pty Ltd expressly warrants that the product is free from operational defects in workmanship and materials for the warranty period as shown on the schedule in the manufacturer's warranty. During the warranty period, Galvin Engineering will replace or repair any defective products manufactured by Galvin Engineering without charge, so long as the terms of the Manufacturer's warranty are complied with.

The remedy described in the first paragraph of this warranty shall constitute the sole and exclusive remedy for breach of warranty, and Galvin Engineering Pty Ltd shall not be responsible for any incidental, special or consequential damages, including without limitation, lost profits or the cost of repairing or replacing other property which is damaged if this product does not work properly, other costs resulting from labour charges, delays, vandalism, negligence, fouling caused by foreign material, damage from adverse water conditions, chemical, electrical or any other circumstances over which Galvin Engineering has no control. This warranty shall be invalidated by any abuse, misuse, misapplication, improper installation or improper maintenance or alteration of the product.

